

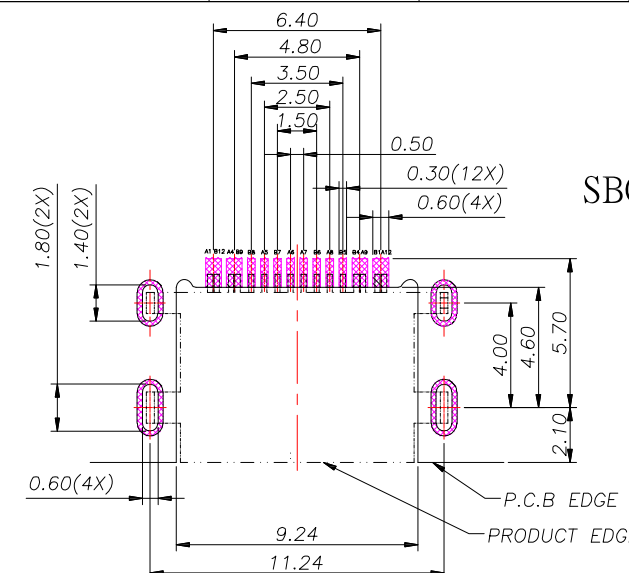

# SBC-160M5A-20x-S412

鍍層厚度：

Blank : 1u"
2 : 15u"
3 : 30u"

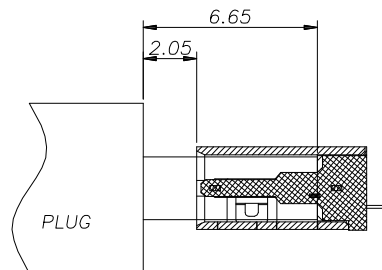
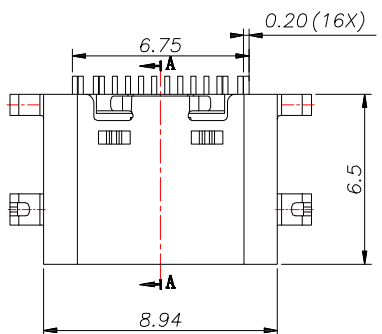

RECOMMENDED PCB LAYOUT

USB TYPE-C PIN ASSIGNMENTS

PIN NUMBER	SIGNAL NAME	PIN NUMBER	SIGNAL NAME
A1	GND	B12	GND
A4	VBUS	B9	VBUS
A5	CC1	B8	SBU2
A6	Dp1	B7	Dn2
A7	Dn1	B6	Dp2
A8	SBU1	B5	CC2
A9	VBUS	B4	VBUS
A12	GND	B1	GND

SPECIFICATIONS

Electrical:

- 1.Rating: 5.0V , 3.0 A
- 2.Contact Resistance: 40 mΩ Max
- 3.Insulation Resistance: 100 MΩ Min

Mechanical:

- 1.Connector Mate and Unmate Force
  - 1.1 Mate force: 5~20 N
  - 1.2 Unmate force: 8~20 N

Material:

- 1.Housing: LCP
- 2.Contact: C7025
- 3.Shell: SUS

Finish:

- 1.Contact: Plated Gold in Mating Area ;  
Gold Plated on Solder Balls ;  
Nickel under plated overall
- 2.Shell: Nickel under Plated surface layer

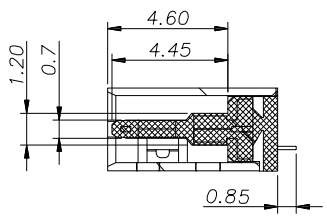
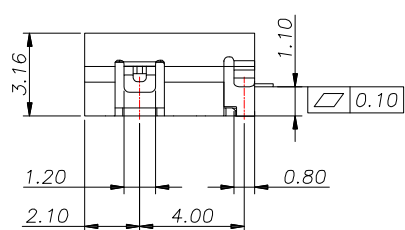
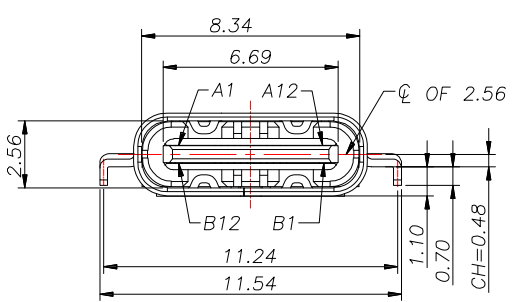

SECTION:A-A

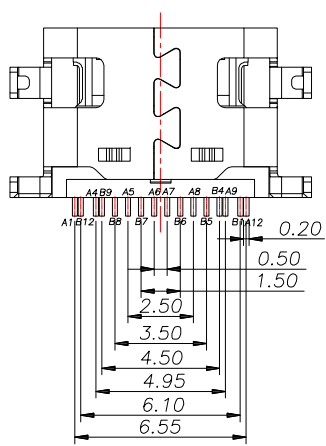

**CONTACT** 建倚科技股份有限公司  
CONTACT TECHNOLOGY CORP.

TOLERANCE UNLESS OTHERWISE STATED:	Up to 5 ±0.2	3RD. ANGEL'S	UNITS	MM
	Above 5 ~ 15 ±0.3			
	Above 15 ~ 30 ±0.4			
	Above 30 ~ 50 ±0.5			
	Angle ±0.3°			

DRAWN BY:	DATE	MAT'L	TITLE	CONNECTOR
Jack Lu	01/03/24			
CHECKED BY:	DATE	FINISH	MODLE	USB TYPE C 2.0 沉板 1.1mm
Jacky Chen	01/03/24			
APPROVED BY:	DATE	SCALE	DWG NO.	SBC-160M5A-20x-S412
Tony Kao	01/03/24	1 : 1	PART NO.	SBC-160M5A-20x-S412
		SHEET NO.	1 of 1	SIZE A4
				VER R3

ITEM NO.	DESCRIPTION	DRAWN	DATE
3	更新尺寸	Jack	010324
2	更新鍍層	Jack	091421
1	更新材質	Jack	091321